

8 Timbers
Conscious
Live Person

Face

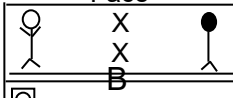

Body

Knee Deep
Water

Roof Bolting
Machine

Face

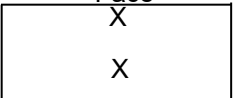

1.5% CH4
18% O2
0 PPM CO

Face

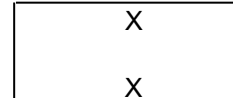

Continuous
Mining Machine

1.5% CH4
18% O2
0 PPM CO

5.0% CH4
18% O2
0 PPM CO



X BC

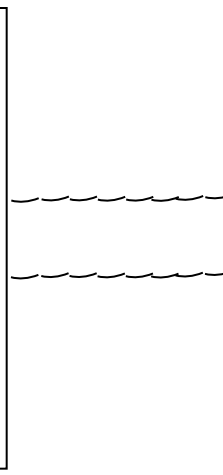
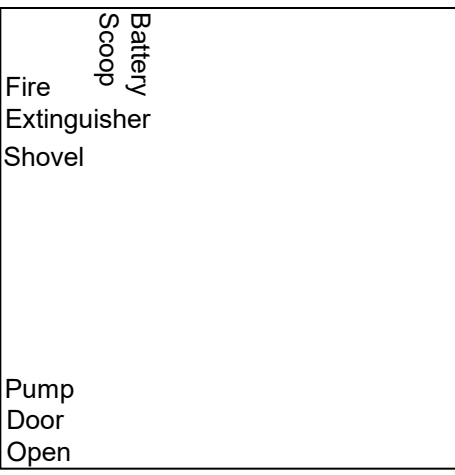
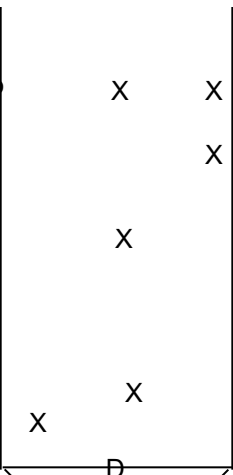
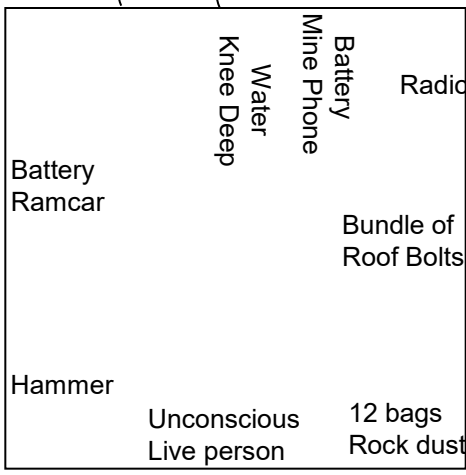

1.5% CH4
18% O2
0 PPM CO

Water
Knee Deep

Water
Knee Deep

Oil Can

1.5% CH4
18% O2
0 PPM CO

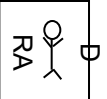

1.5% CH4
18% O2
0 PPM CO

Power
Center



X BC

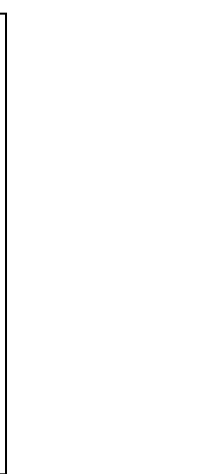
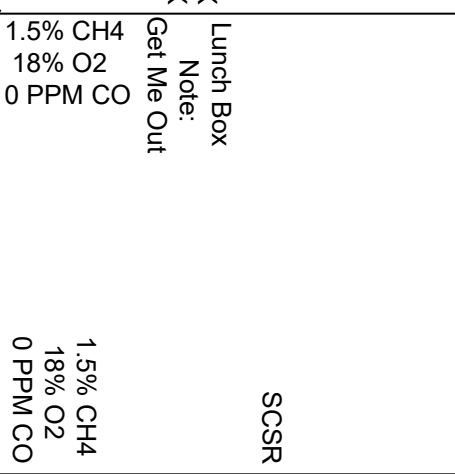
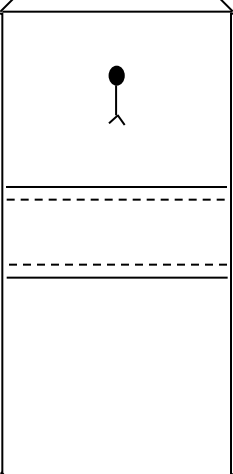
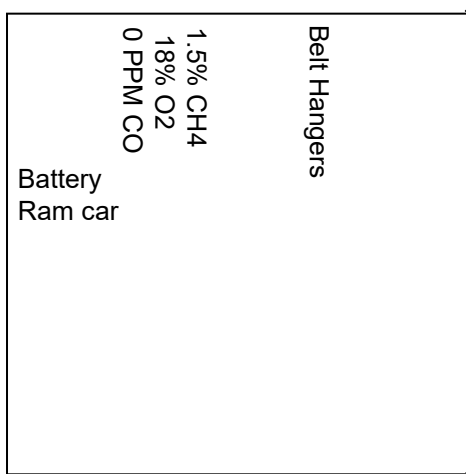

Unsafe
Roof



1.5% CH4
18% O2
0 PPM CO

1.5% CH4
18% O2
0 PPM CO

5.0% CH4
18% O2
0 PPM CO



5.0% CH4
18% O2
0 PPM CO

BC

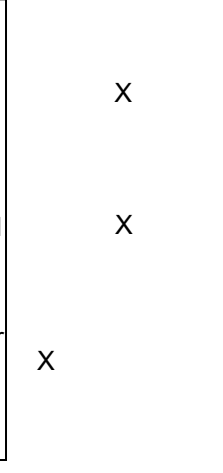
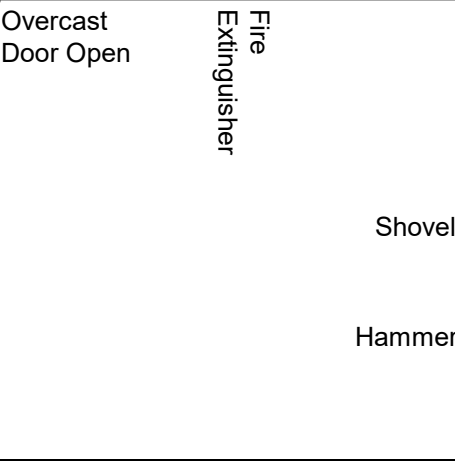
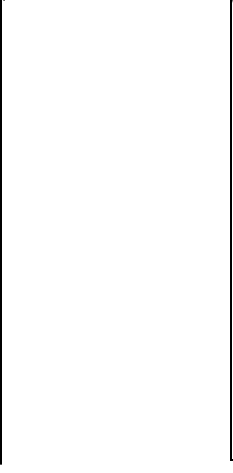
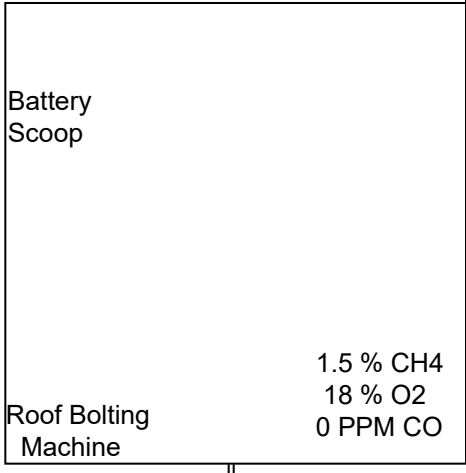

Battery
Ram car

Methane
Detector



1.5 % CH4
18 % O2
0 PPM CO



1.5% CH4
18% O2
0 PPM CO

TEAM NO. _____
FIELD NO. _____
SCALE 1" = 10'

10' Diameter
Shaft

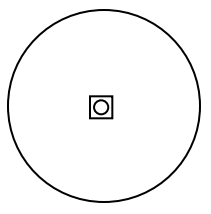

BC

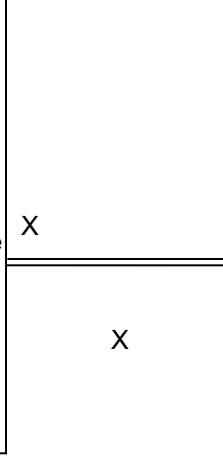
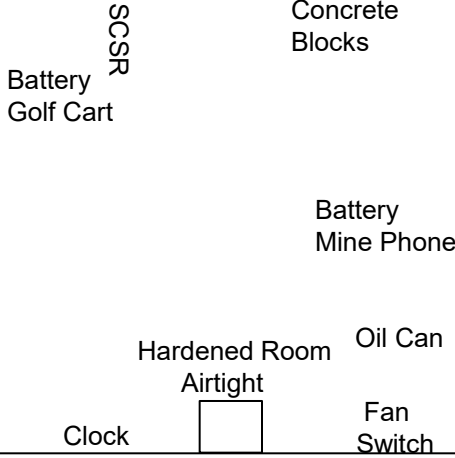
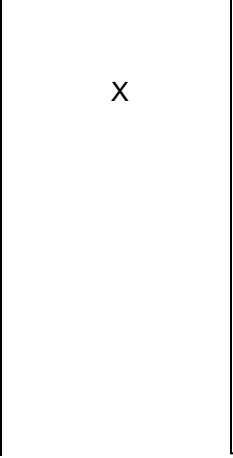
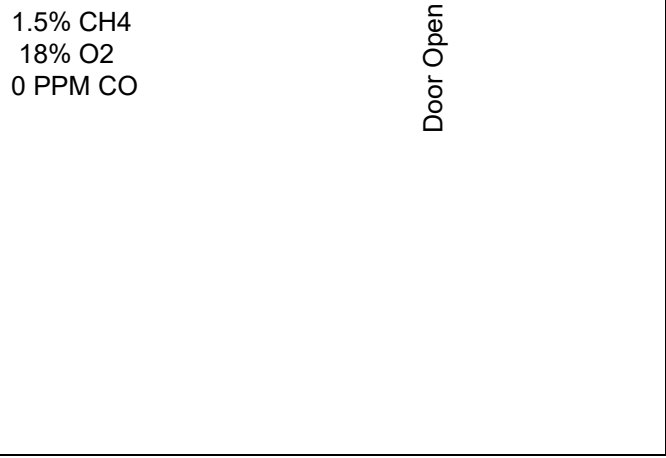

1.5% CH4
18% O2
0 PPM CO

LC

BO

BC

BC

2013 Illinois Mine Rescue Contest

8 Timbers
Conscious
Live Person

1.5% CH4
18% O2
0 PPM CO

5.0% CH4
18% O2
0 PPM CO

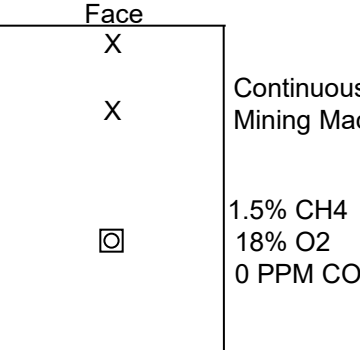
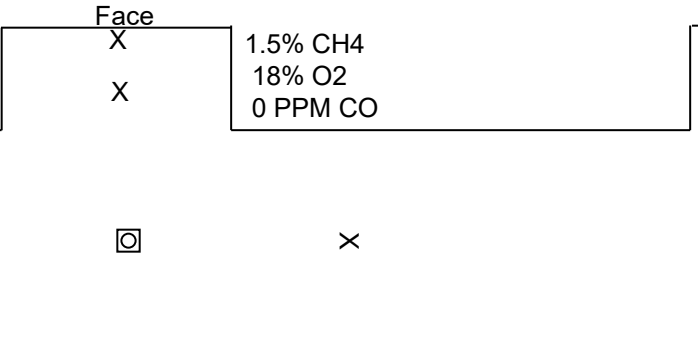
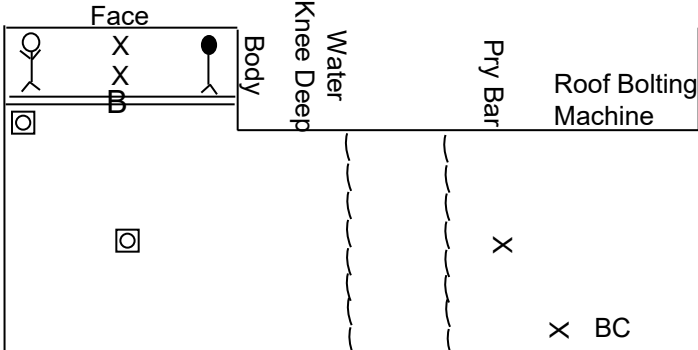

Oil Can

1.5% CH4
18% O2
0 PPM CO

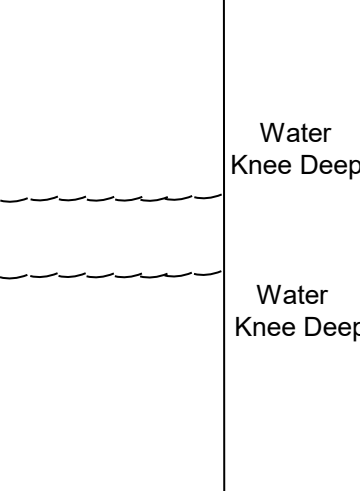
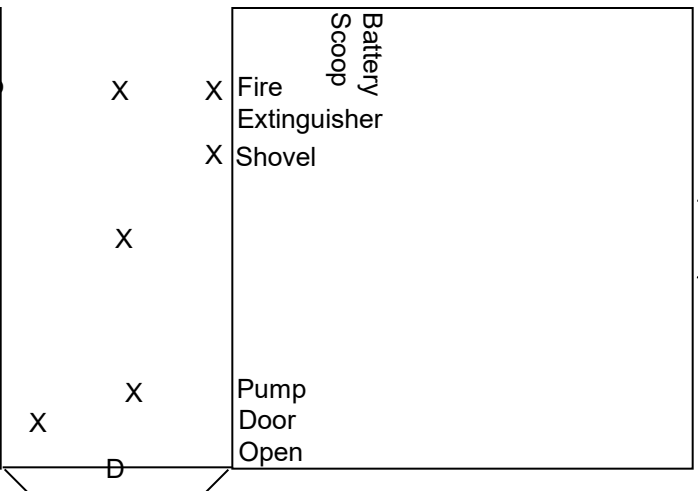
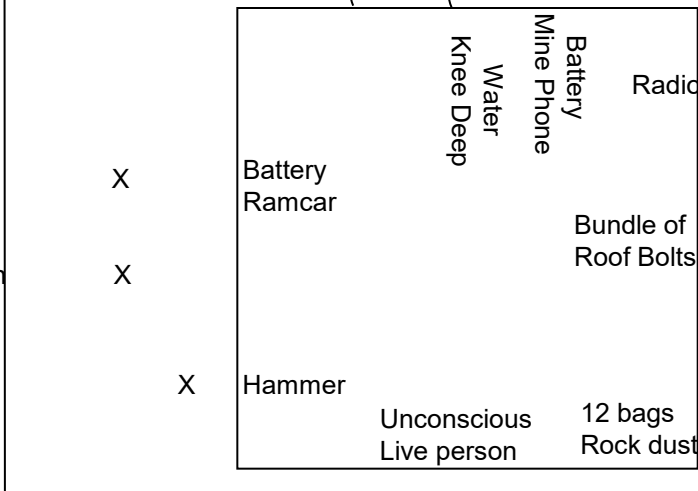

Power Center
Body

Unsafe Roof

1.5% CH4
18% O2
0 PPM CO

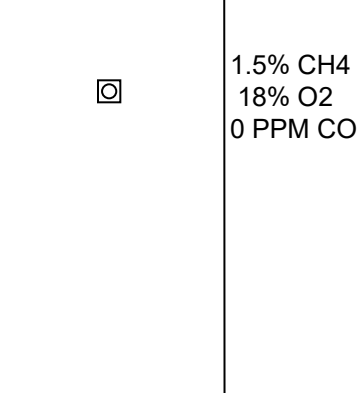
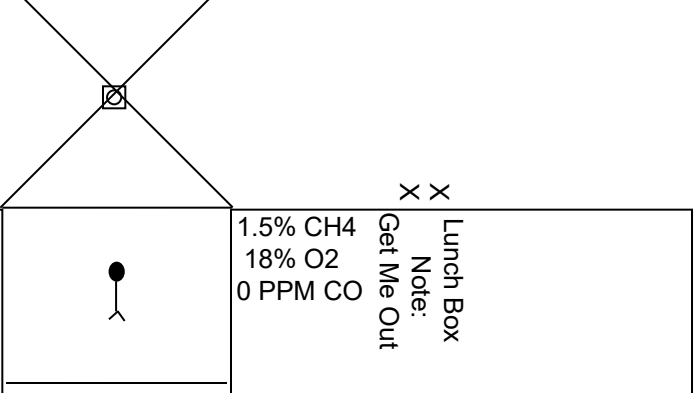
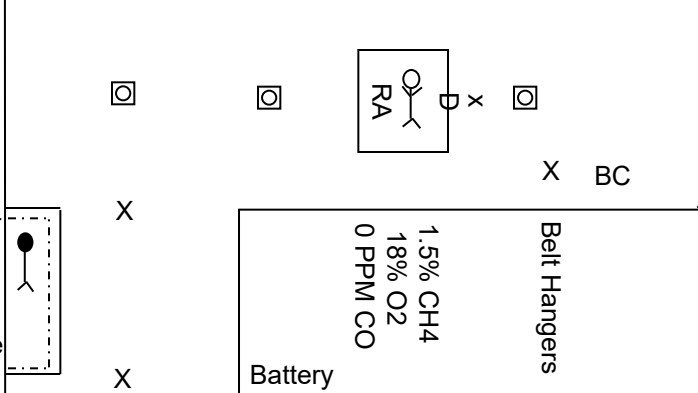

5.0% CH4
18% O2
0 PPM CO

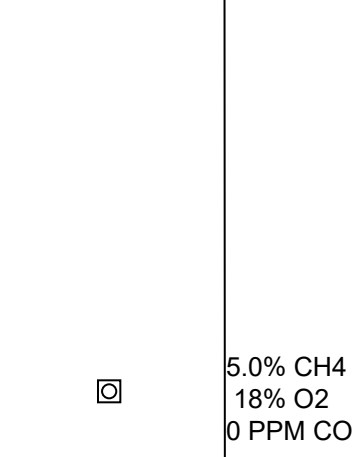
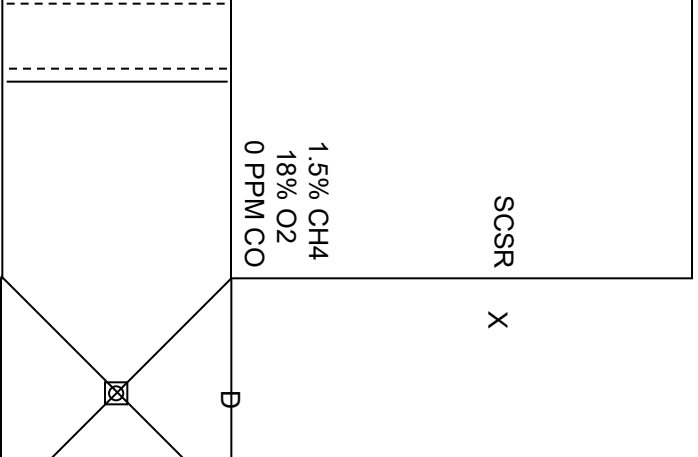
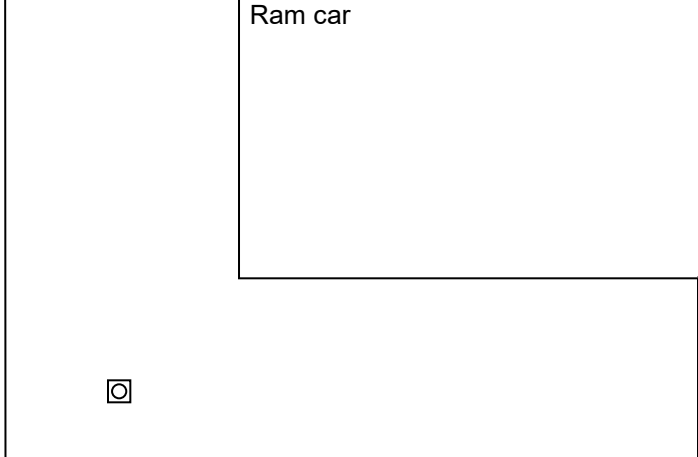

Methane Detector

Pick

10' Diameter Shaft

1.5% CH4
18% O2
0 PPM CO

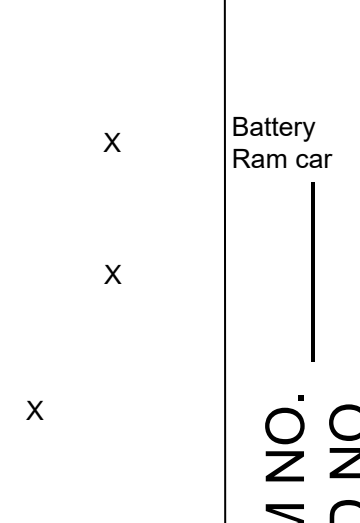
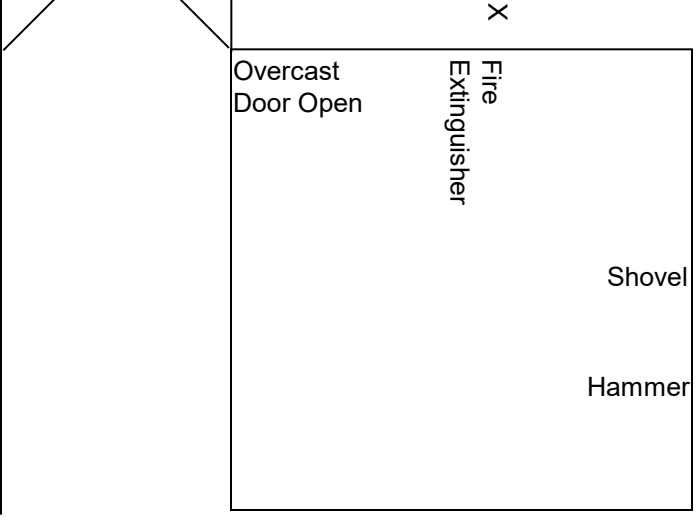
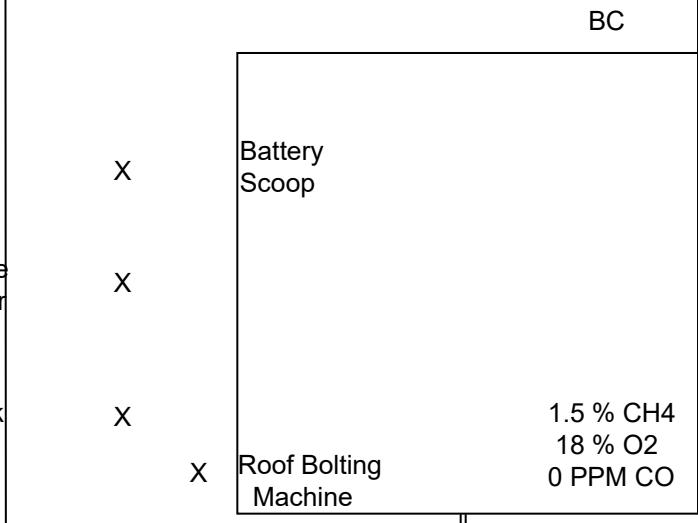

1.5% CH4
18% O2
0 PPM CO

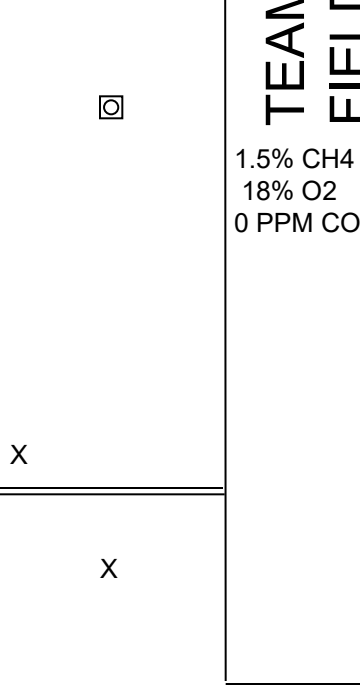
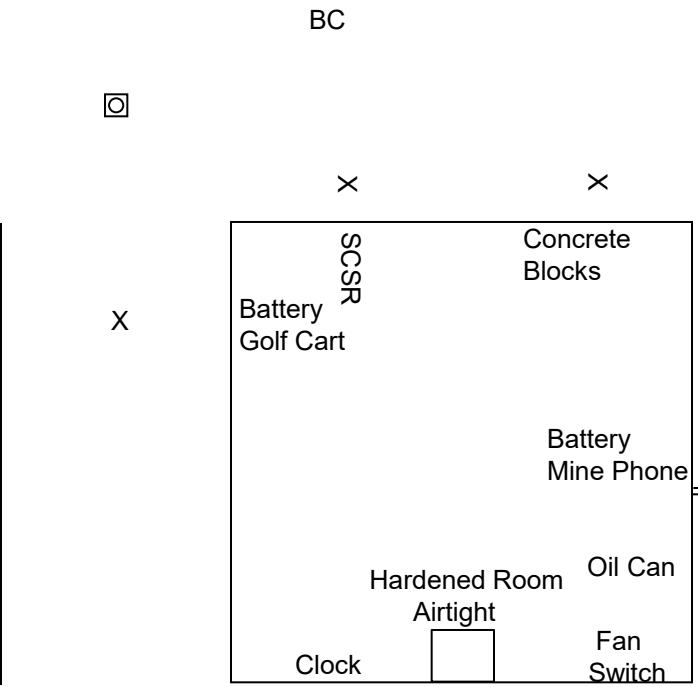
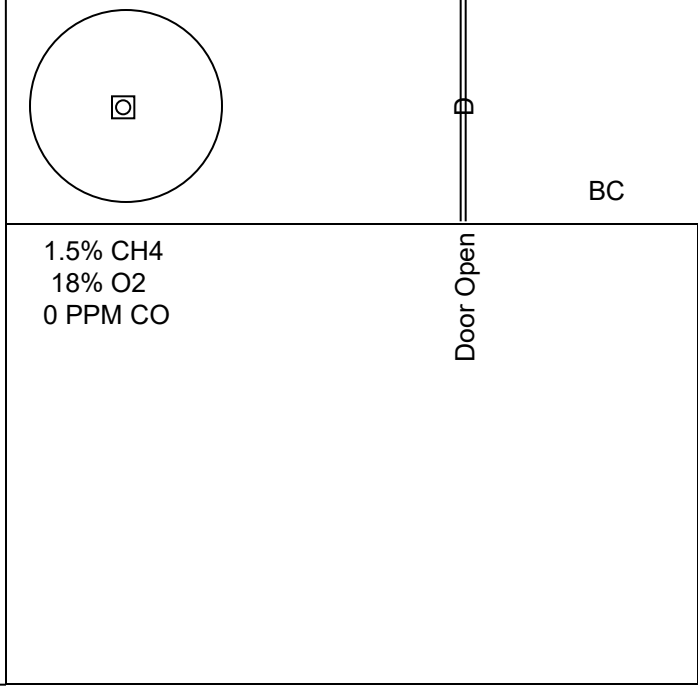

LC

BC



Continuous Mining Machine
 1.5% CH4
18% O2
0 PPM CO
 Water Knee Deep
 Water Knee Deep
 1.5% CH4
18% O2
0 PPM CO
 Lunch Box
Note:
Get Me Out
1.5% CH4
18% O2
0 PPM CO
 SCSR
 5.0% CH4
18% O2
0 PPM CO
 Battery Ram car
 Shovel
 Hammer
 1.5% CH4
18% O2
0 PPM CO
 Concrete Blocks
 Battery Mine Phone
 Oil Can
 Fan Switch
 Clock
 Hardened Room Airtight
 BO
 BC

2013 Illinois Mine Rescue Contest

TEAM NO. _____
 FIELD NO. _____
 SCALE 1" = 10'

8 Timbers
Conscious
Live Person

1.5% CH4
18% O2
0 PPM CO

5.0% CH4
18% O2
0 PPM CO

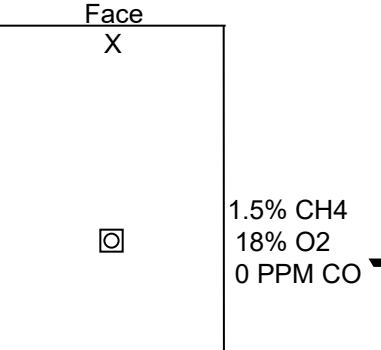
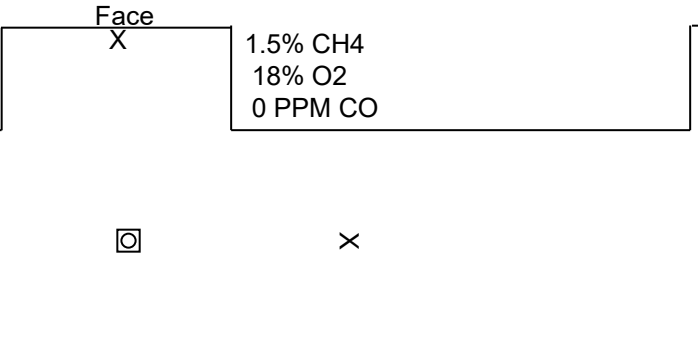
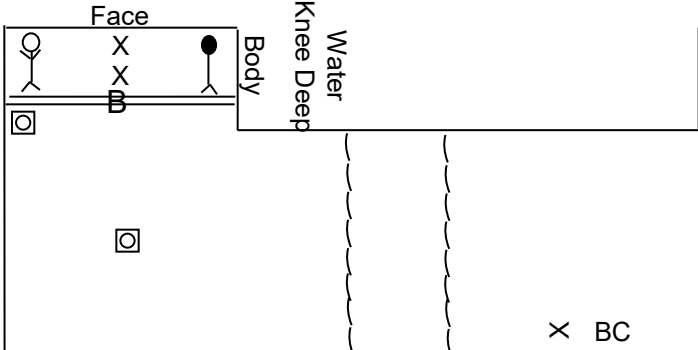

1.5% CH4
18% O2
0 PPM CO

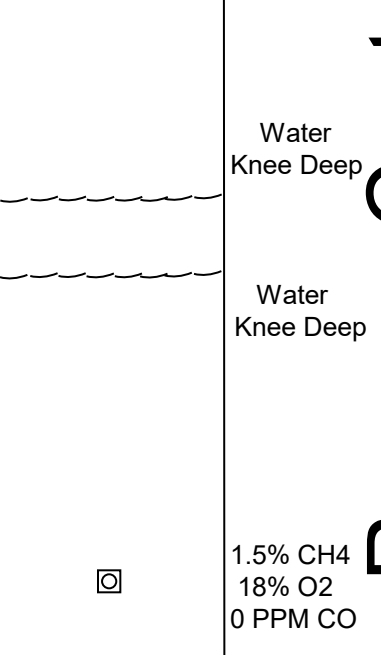
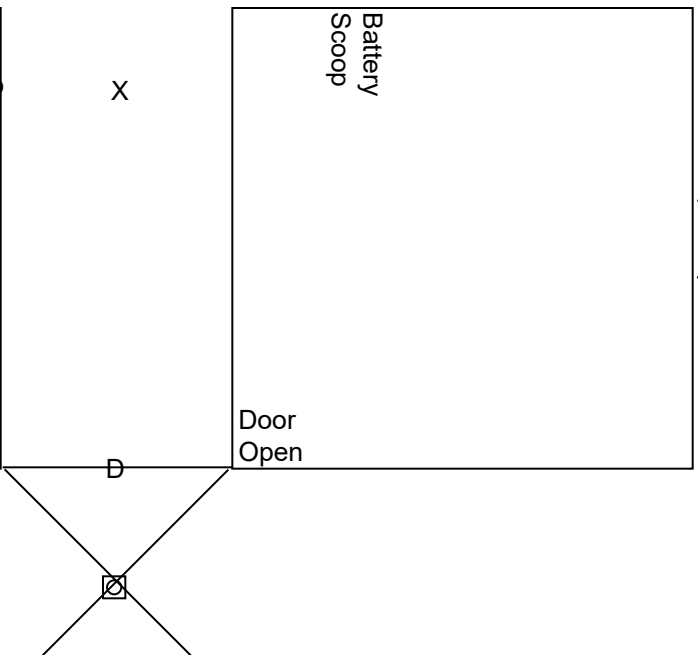
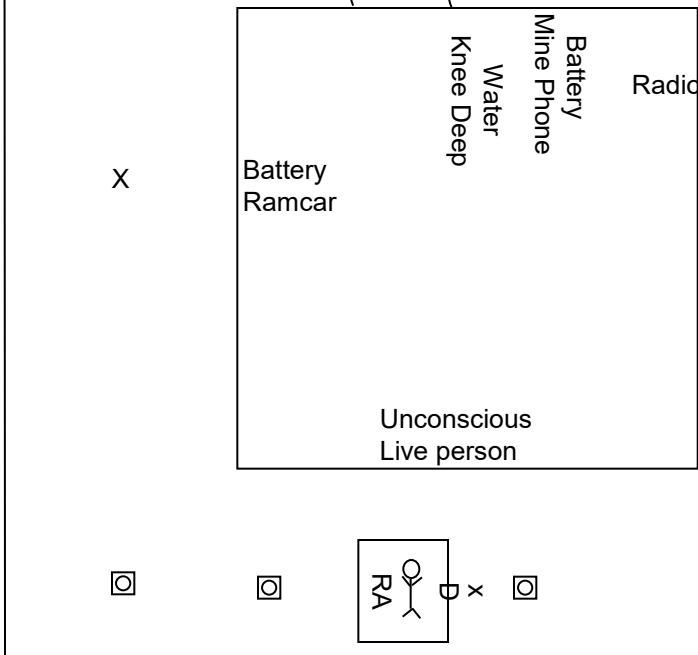

5.0% CH4
18% O2
0 PPM CO

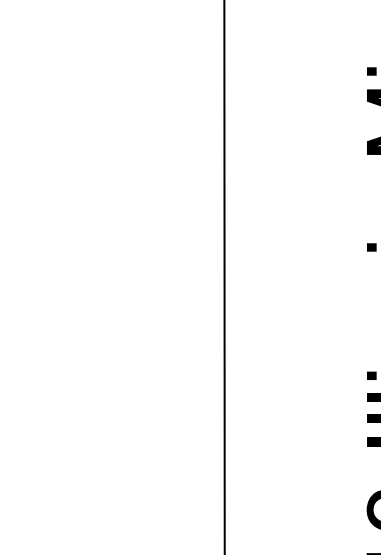
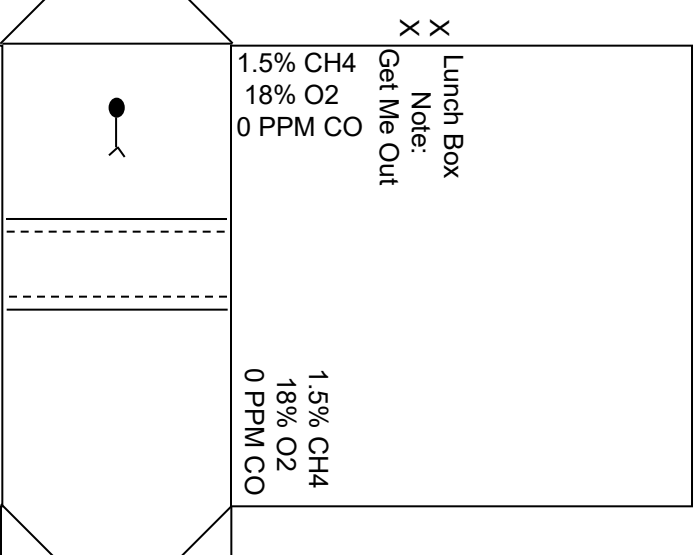
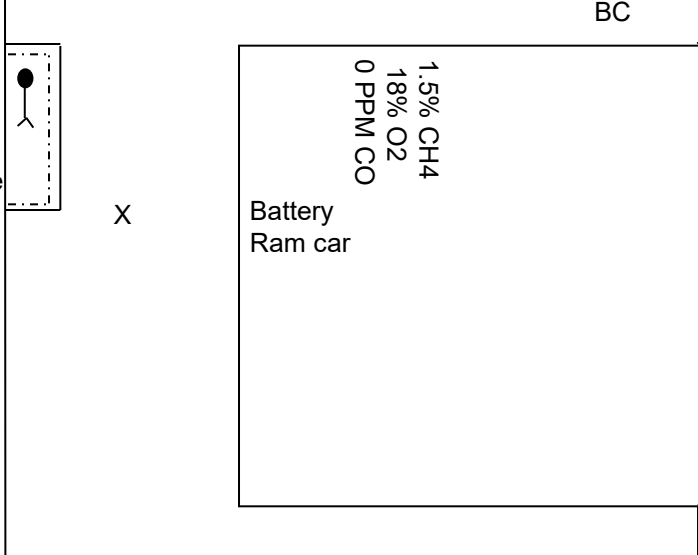

10' Diameter Shaft

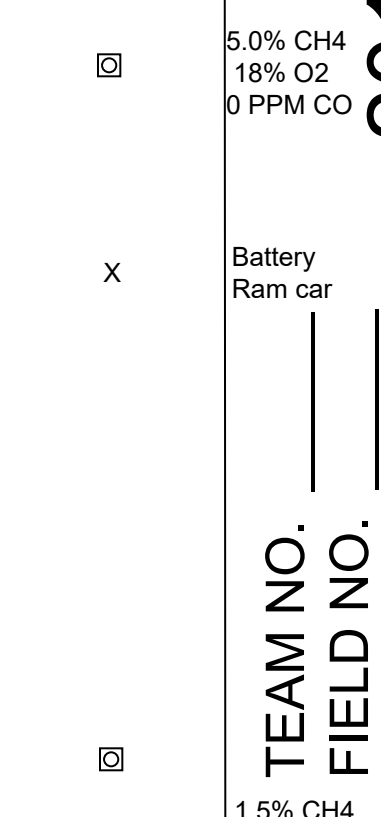
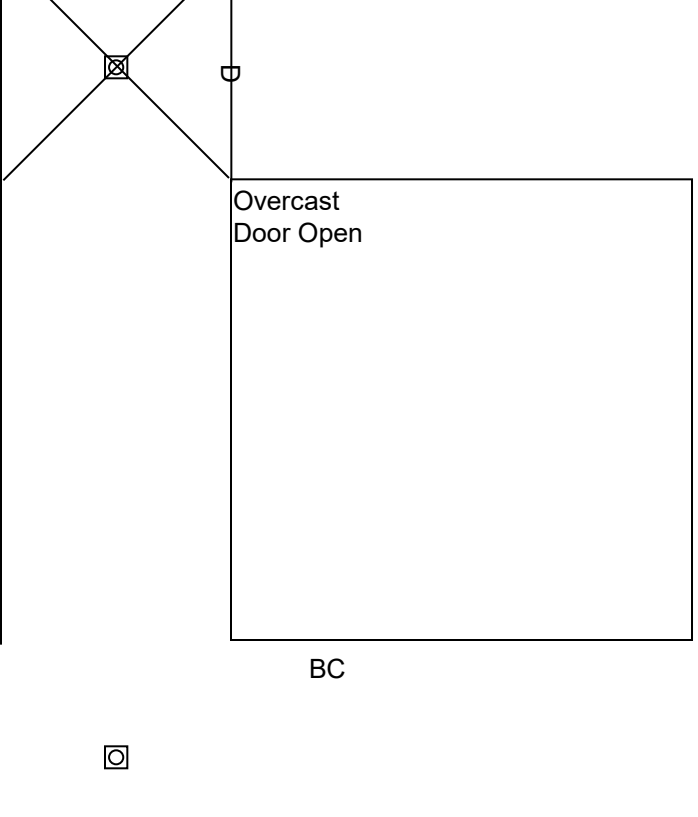
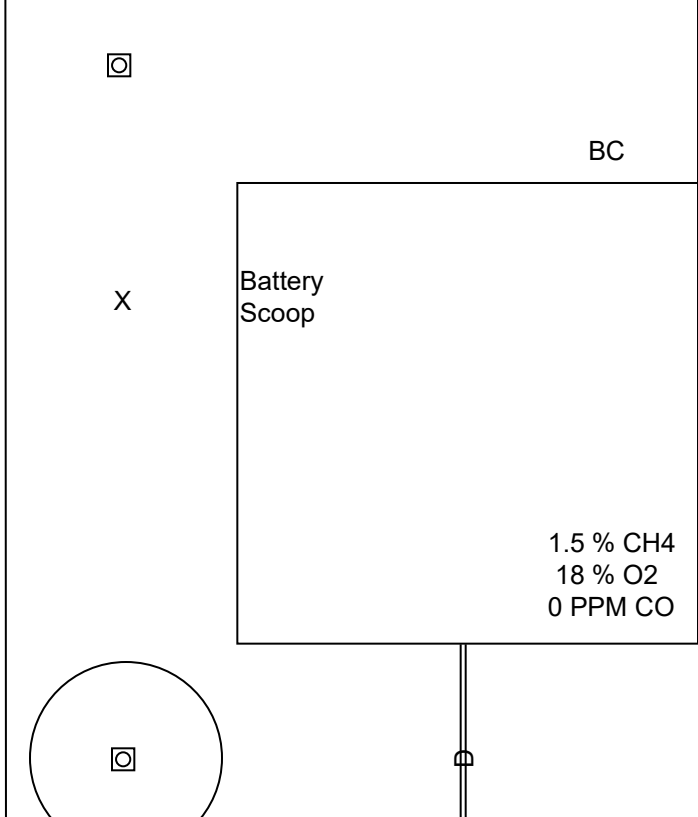

1.5% CH4
18% O2
0 PPM CO

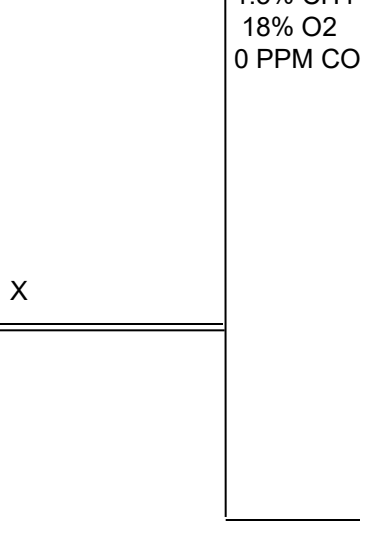
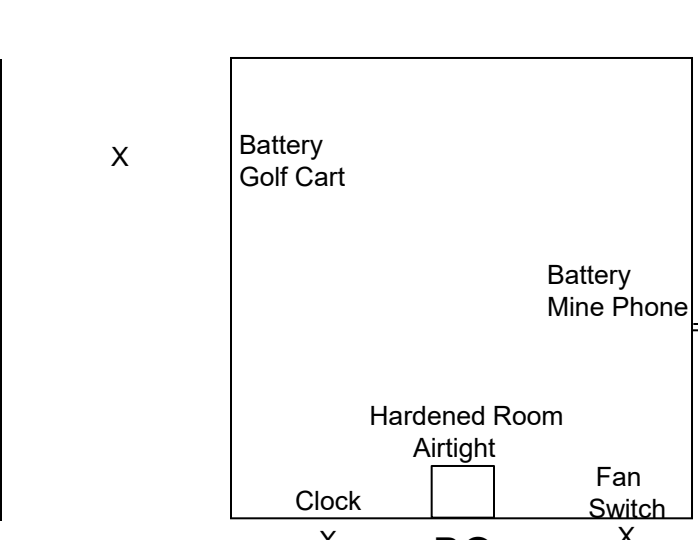
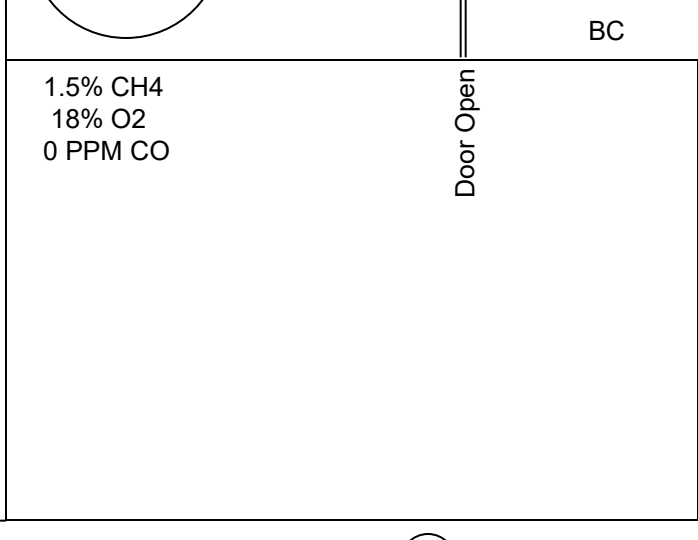

LC

BO

BC

BC

Briefing Officer Map

2013 Illinois Mine Rescue Contest

TEAM NO. _____
FIELD NO. _____
SCALE 1" = 10'

1.5% CH4
18% O2
0 PPM CO

2013 Illinois Mine Rescue Contest

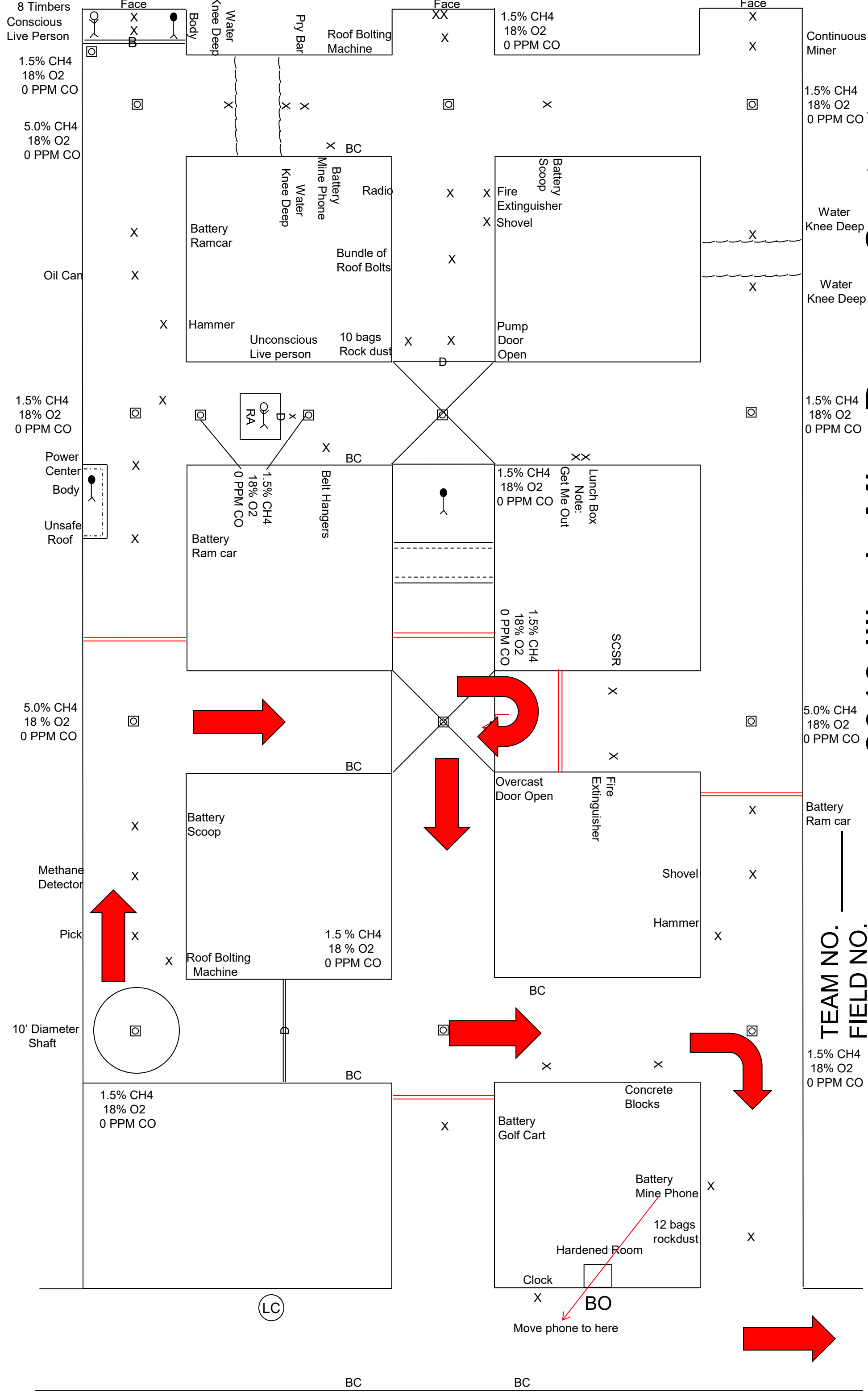

TEAM NO. _____
 FIELD NO. _____
 SCALE 1" = 10'

1st Ventilation

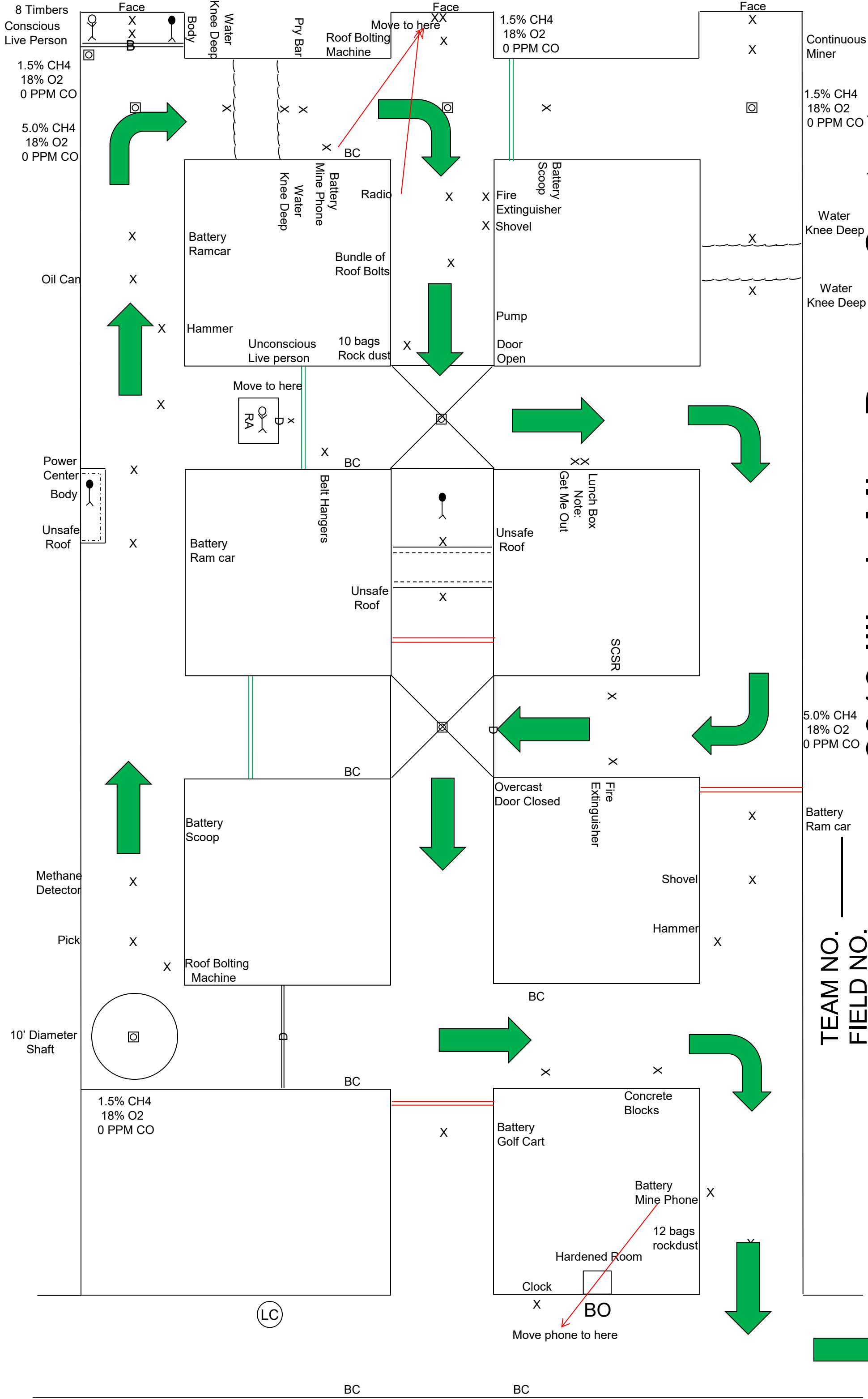

2013 Illinois Mine Rescue Contest

TEAM NO. _____
 FIELD NO. _____
 SCALE 1" = 10'

2nd Ventilation

10' Diameter Shaft

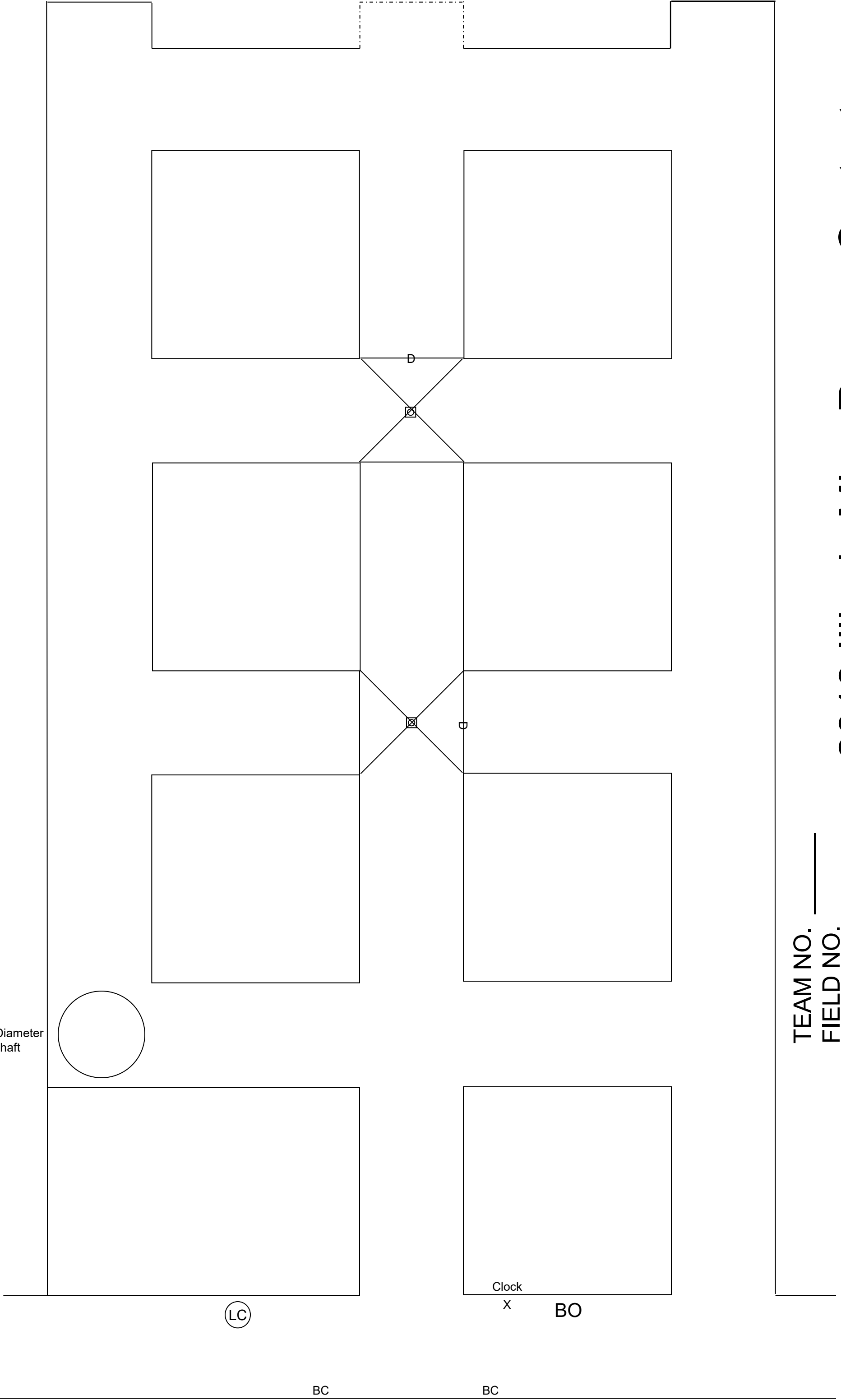
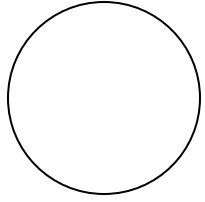

LC

Clock

X

BO

BC

BC

Team Map

TEAM NO. _____
FIELD NO. _____
SCALE 1" = 10'

2013 Illinois Mine Rescue Contest

10' Diameter Shaft

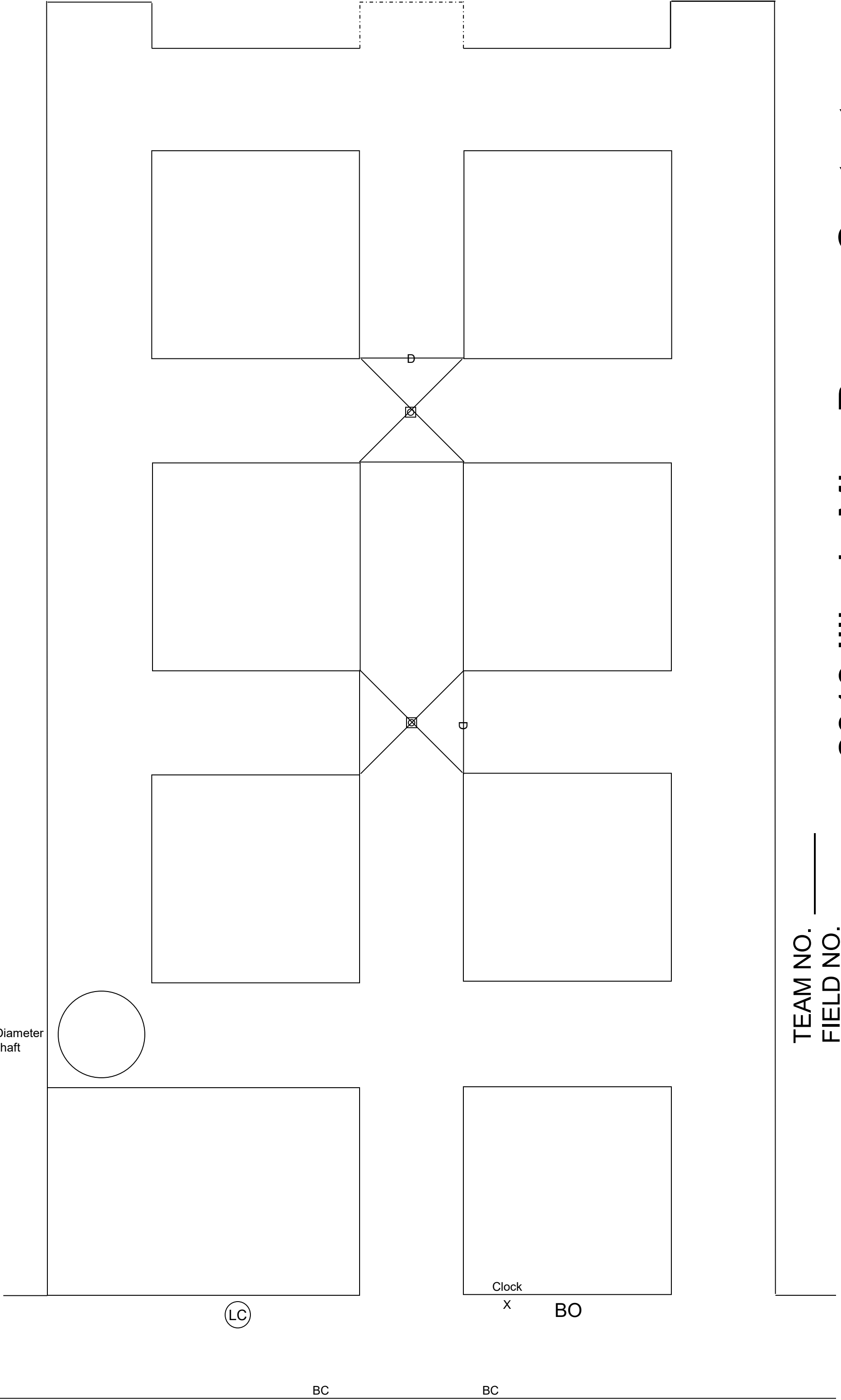
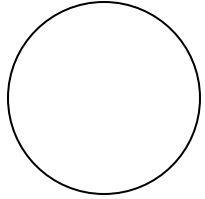

LC

BC

Clock

X

BO

BC

Briefing Officer Map

TEAM NO. _____
FIELD NO. _____
SCALE 1" = 10'

2013 Illinois Mine Rescue Contest